

1. Table of Contents (This Page)
Created on Mon Aug 27 07:03:50 2012

2. Top

3. solder

4. GND

5. Bottom

6. 3.3V Power

7. plated-drill

8. componentmask

9. soldermask

10. topsilk

11. bottomsilk

12. toppaste

13. topassembly

14. bottomassembly

15. fab

front, scale = 1:1.000
/home/schu/Electric Motor /powerboard.pcb

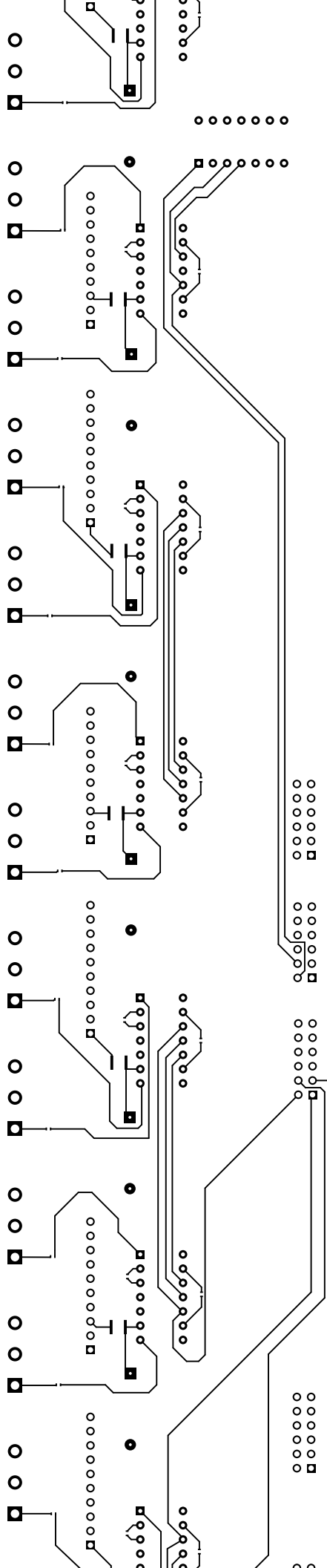

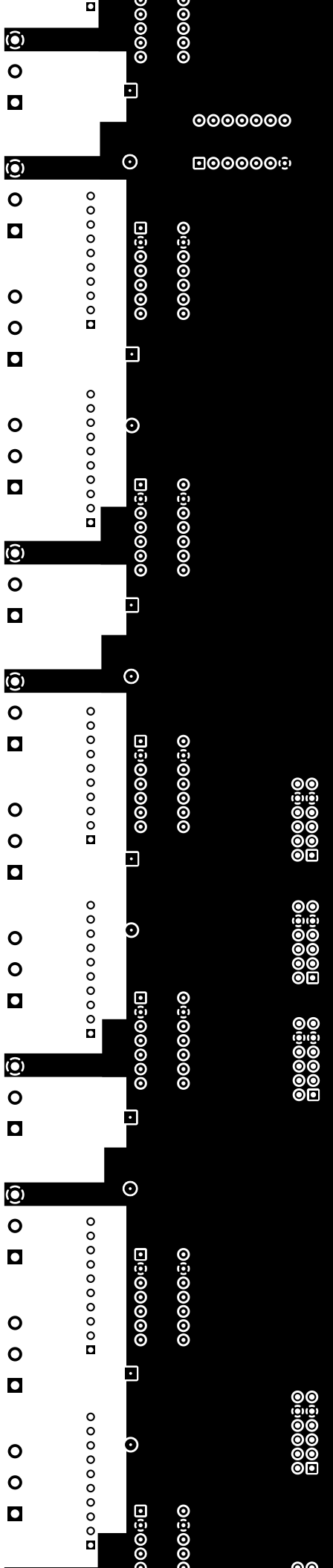

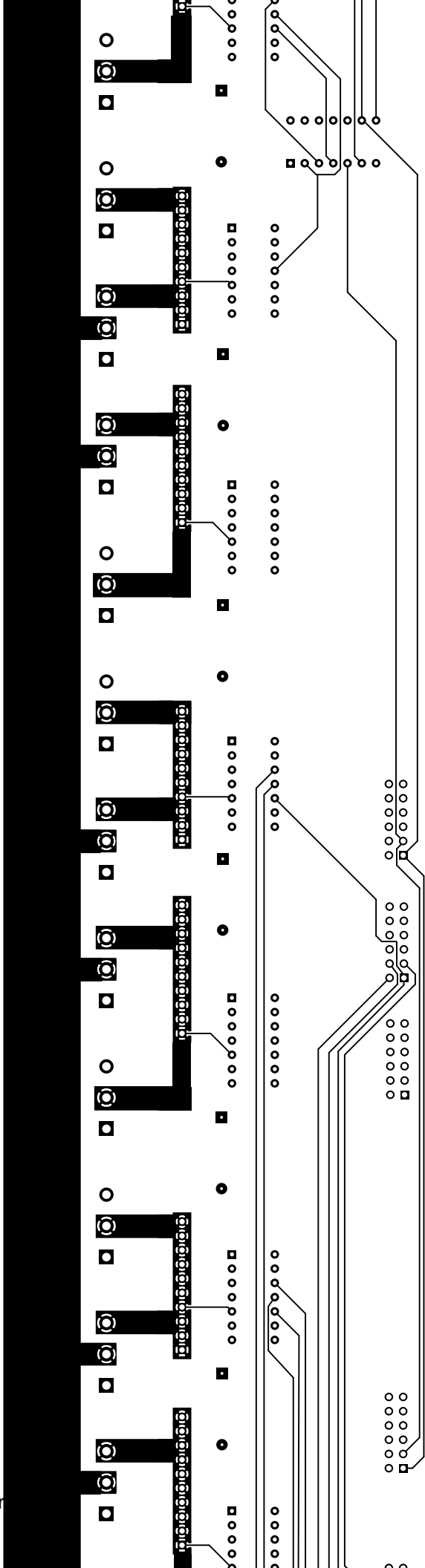

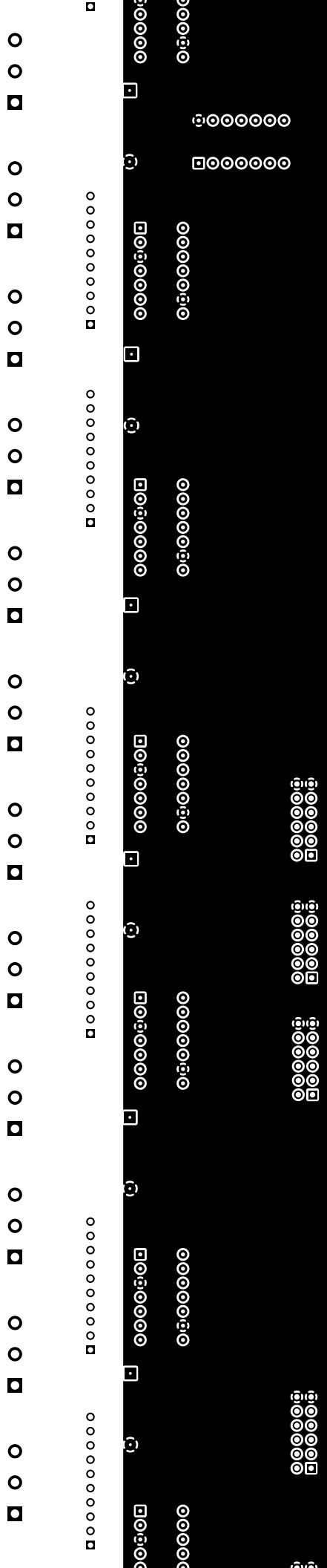

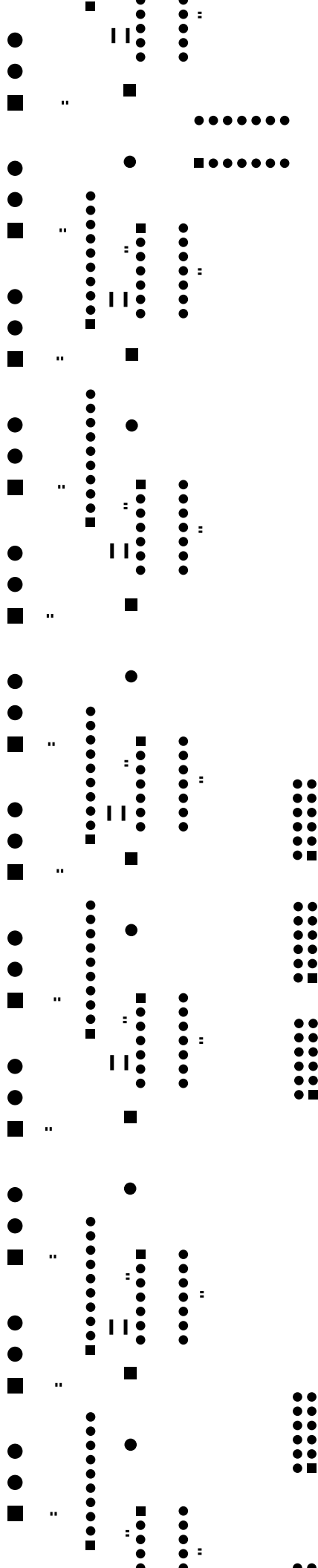

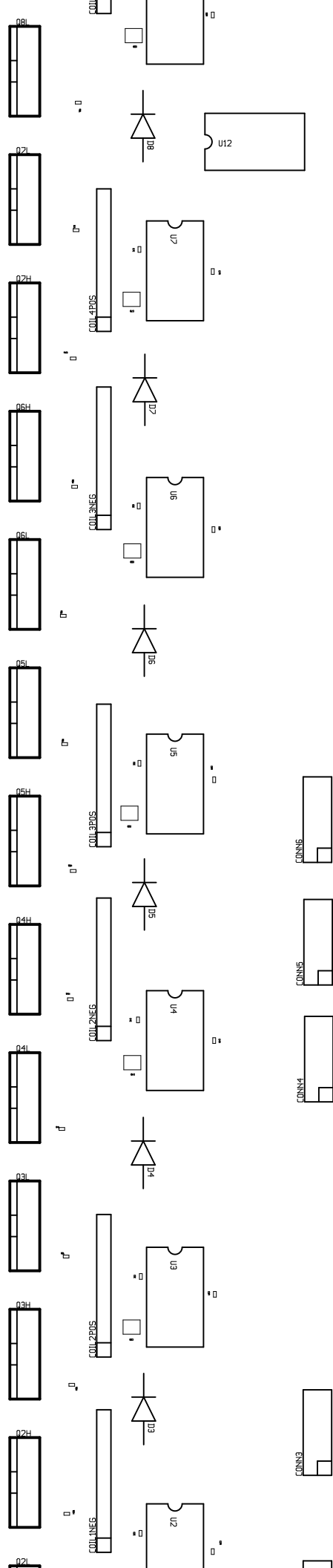

||

..

||

..

||

..

||

..

||

..

||

..

||

frontassembly, scale = 1:1.000
/home/schu/Electric Motor /powerboard.pcb

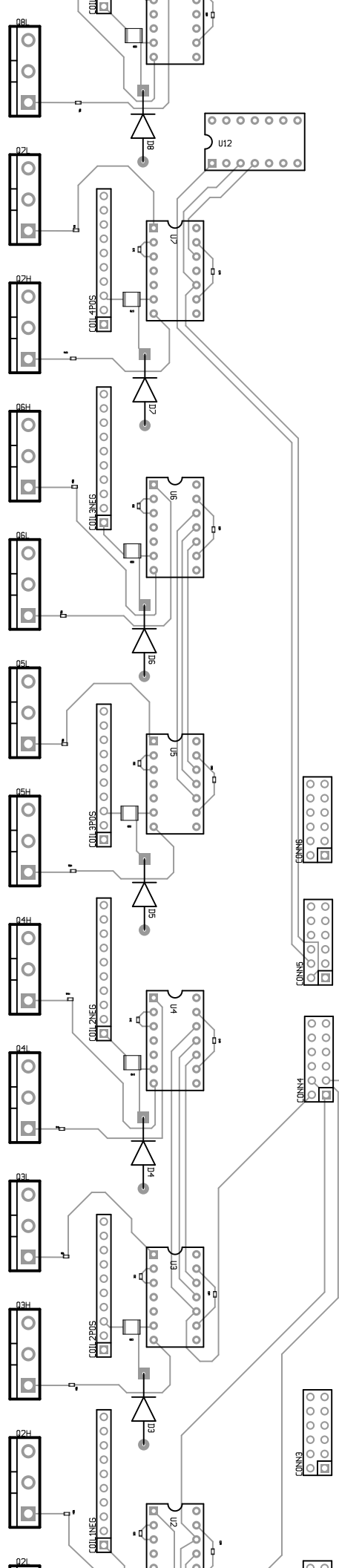

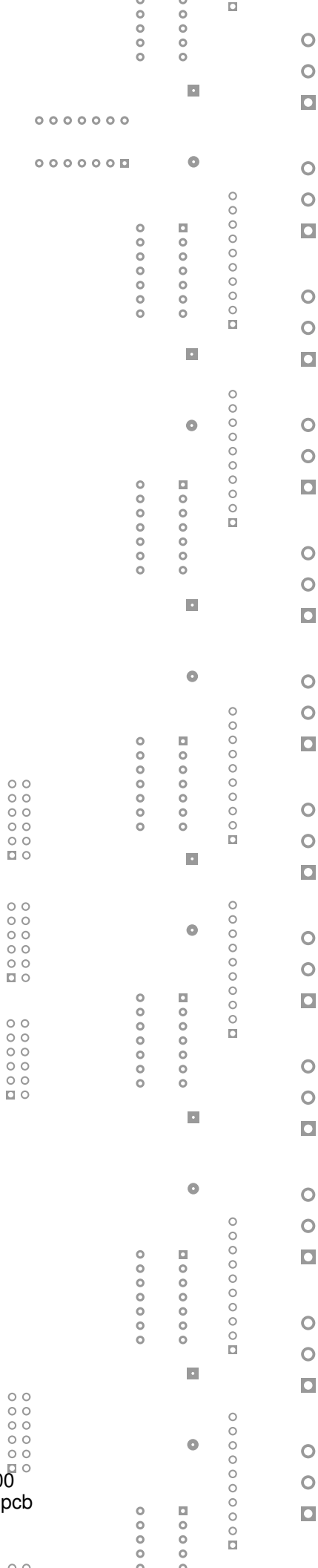

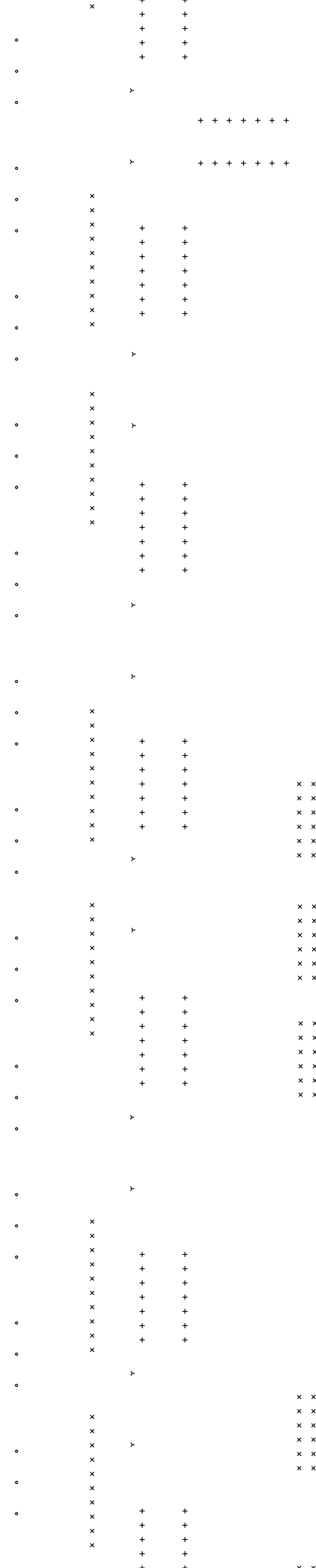

Board outline is the centerline of this 10 mil rectangle - 0,0 to 20000,30000 mils

x x x
x x x
x x x
x x x